

Jade Dragon

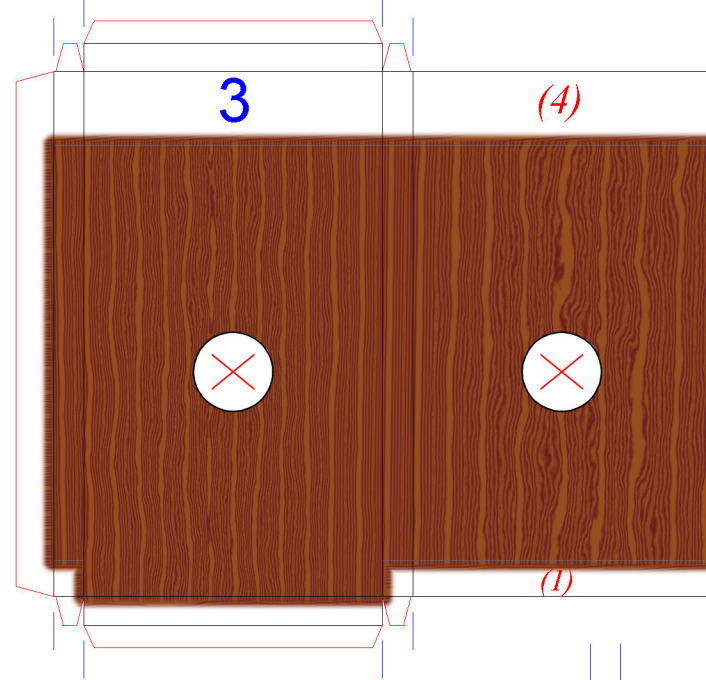

Homespun Magixx
papercraft models and such

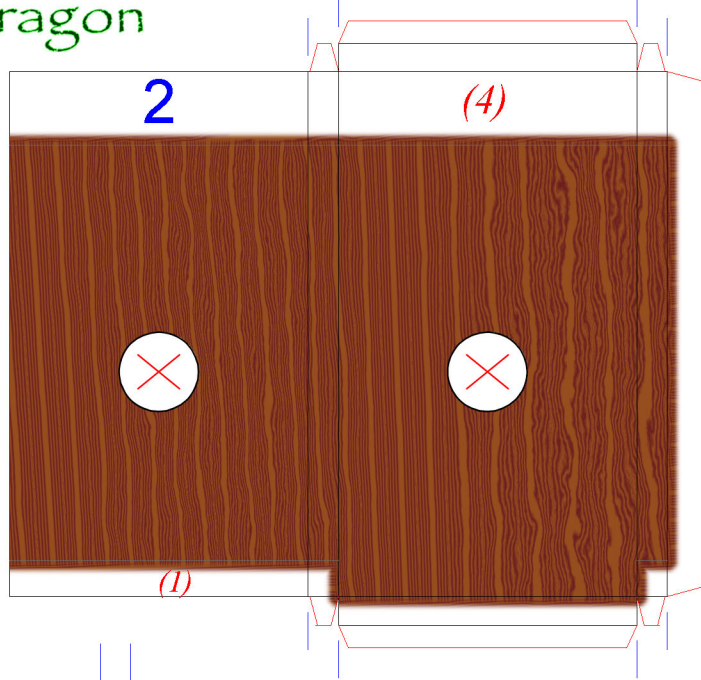

© 2006 Steven Marshall. <http://www.homespunmagixx.com>

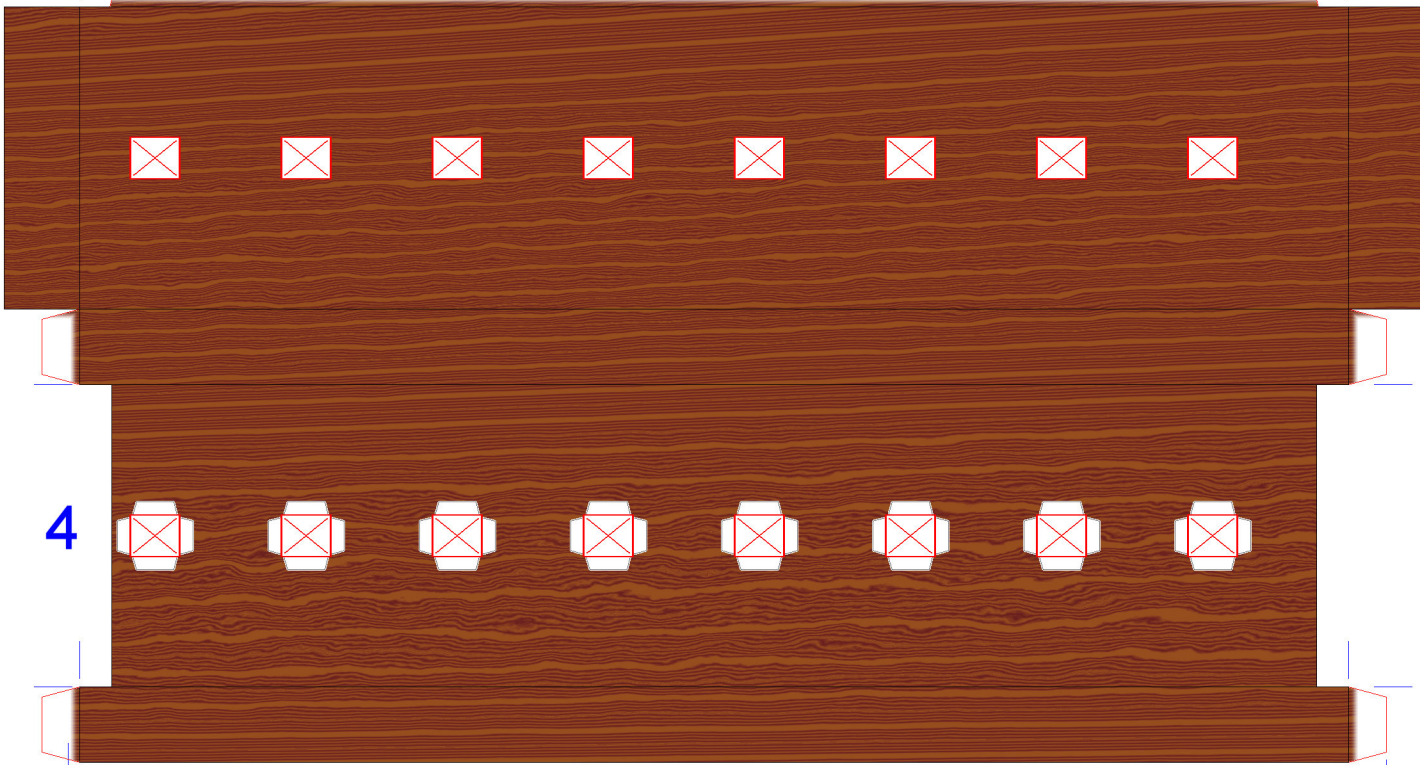

10

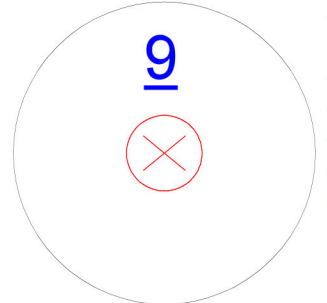
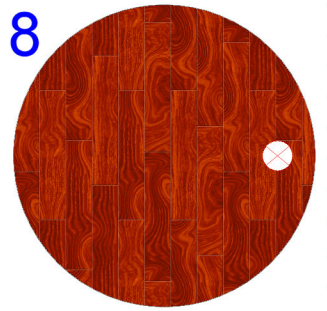
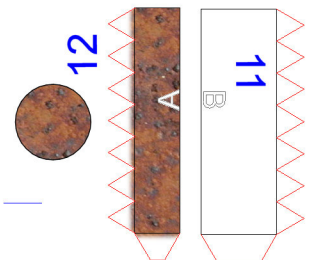

5

Jade Dragon

6r

laminare onto 1mm thick card



6

laminare onto reverse side



18

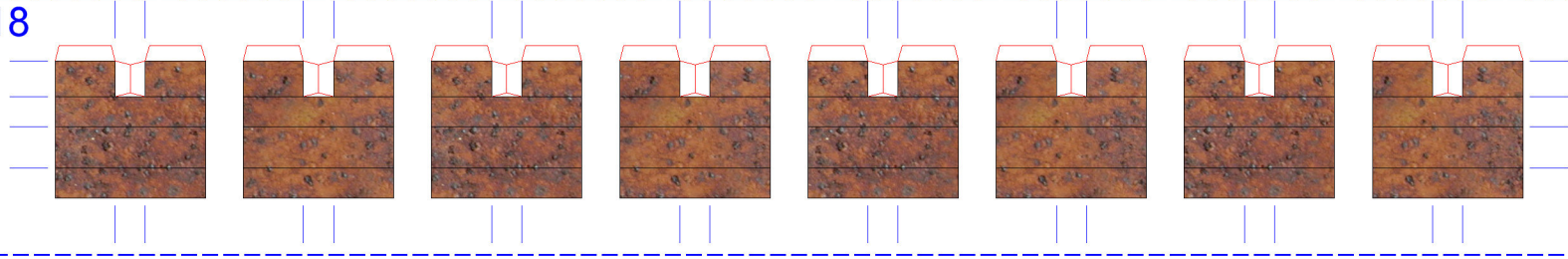

17

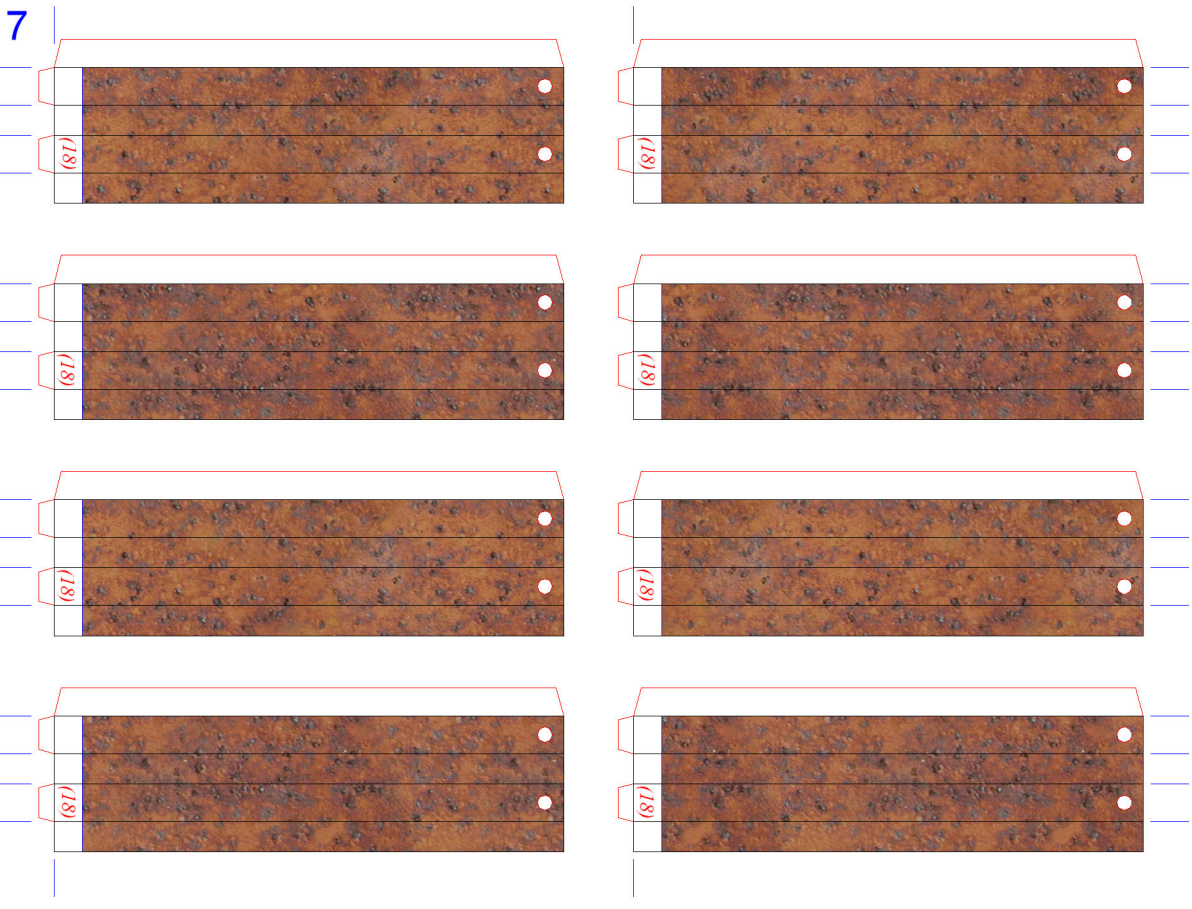

color reverse side of 18 black

19

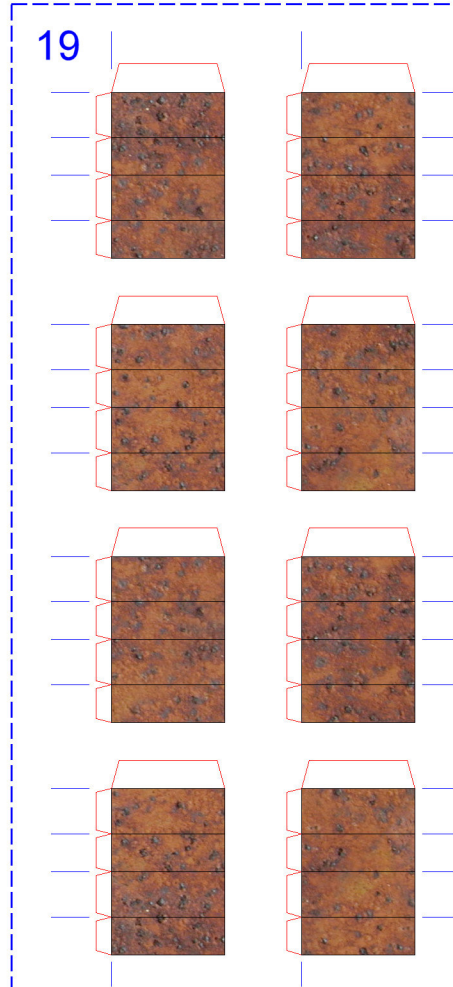

Jade Dragon

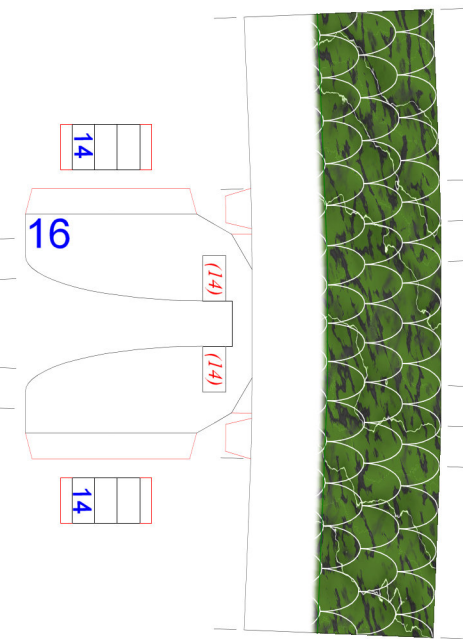
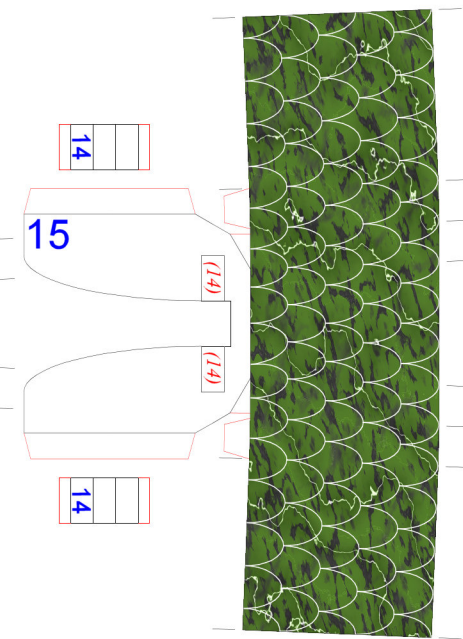
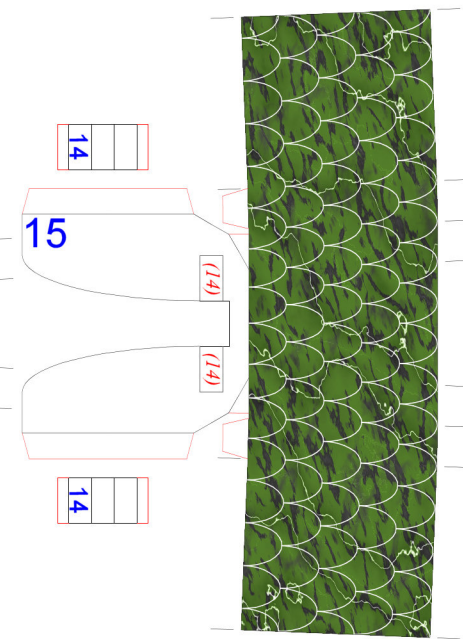
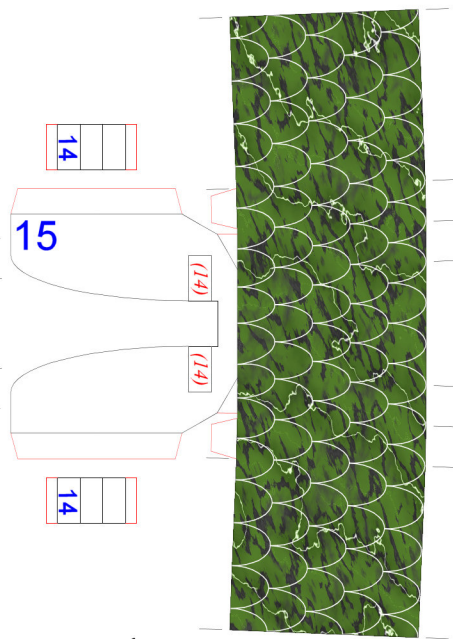
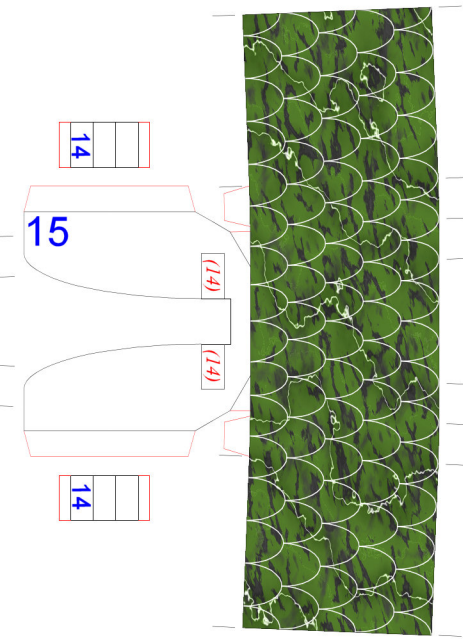
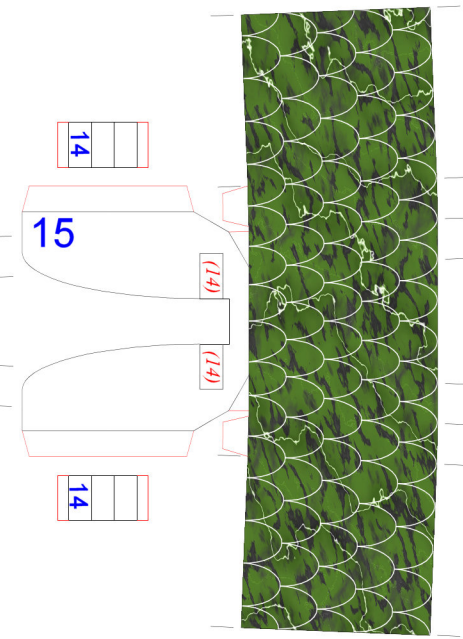
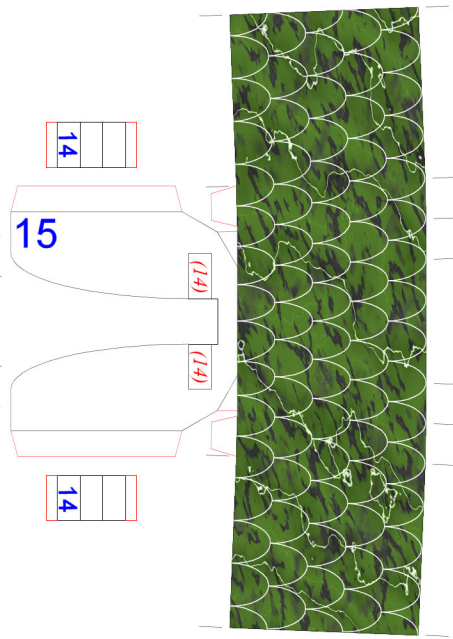

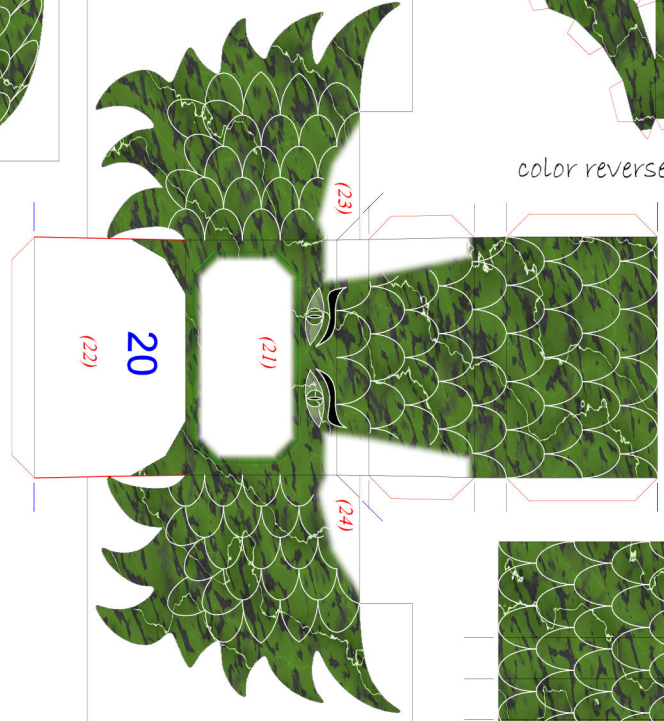
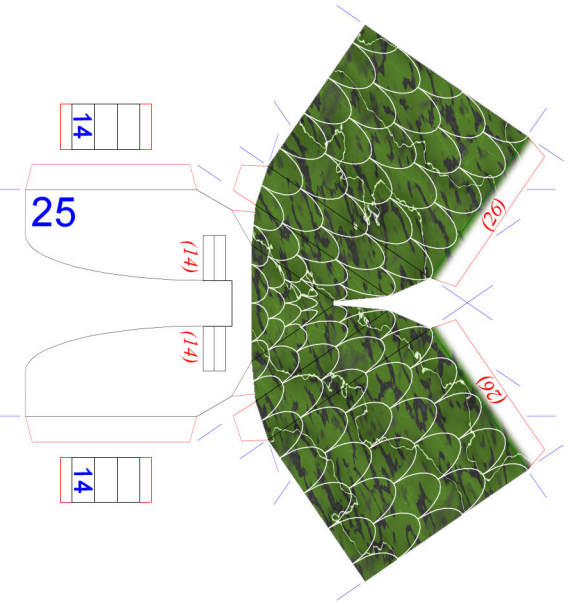
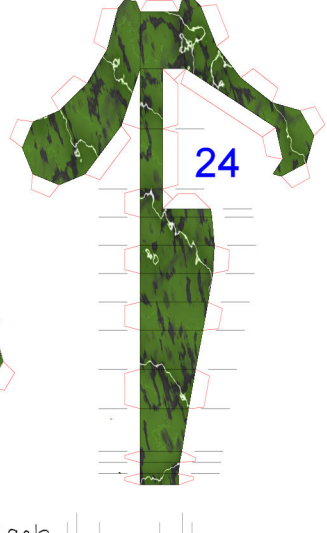
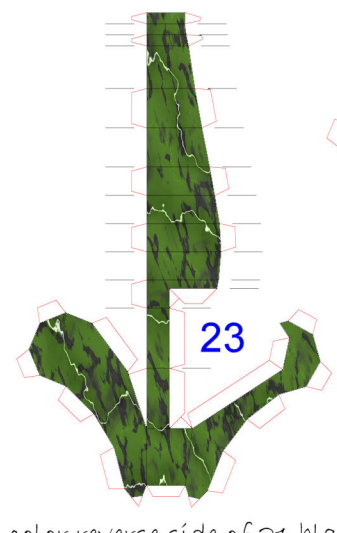
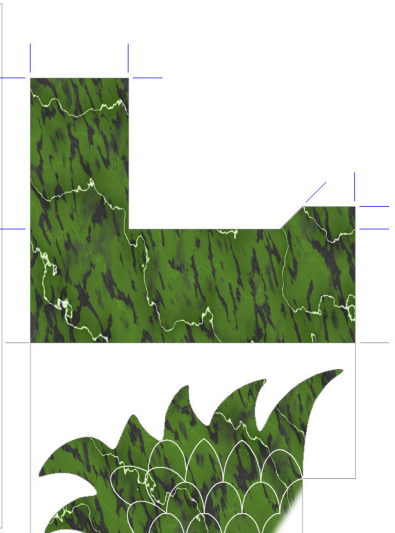
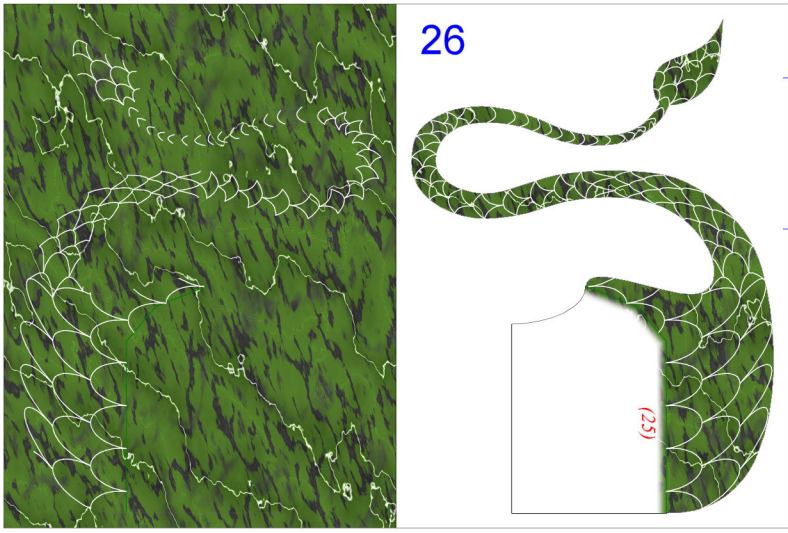

color reverse side of 21 black

